



IGNITION CONTROL MODULE (ICM) REPLACEMENT KIT USA (P/N 476224) AND AUSTRALIA (P/N 476223) FOR MASTERTEMP® AND MAX-E-THERM® POOL AND SPA HEATERS

INSTALLATION INSTRUCTIONS



FAILURE TO FOLLOW ALL INSTRUCTIONS AND WARNINGS CAN RESULT IN SERIOUS BODILY INJURY OR DEATH. THIS PRODUCT SHOULD BE INSTALLED AND SERVICED ONLY BY A QUALIFIED POOL SERVICE PROFESSIONAL. INSTALLERS, POOL OPERATORS AND OWNERS MUST READ THESE WARNINGS AND ALL INSTRUCTIONS IN THE HEATER INSTALLATION AND USER'S GUIDE BEFORE USING THIS PRODUCT. THESE INSTRUCTIONS MUST BE LEFT WITH THE POOL OWNER.

Pentair Water Pool and Spa heater related products are available at:
<https://www.pentair.com/en/products/pool-spa-equipment/pool-heaters.html>
Call (800) 831-7133 for additional free copies of these instructions.

IMPORTANT SAFETY INSTRUCTIONS

READ AND FOLLOW ALL INSTRUCTIONS - SAVE THESE INSTRUCTIONS

Fenwal® Ignition Control Model (ICM)

The following instructions describe how to replace an existing Ignition Control Module (ICM) into a MasterTemp or Sta-Rite pool and spa heater (USA and Australia models) that doesn't have RS-485 communication capability.

Contents

ICM Replacement (USA) page 2-5

ICM Replacement (Australia) page 6-9

HEATER ICM REPLACEMENT INSTRUCTIONS (USA)

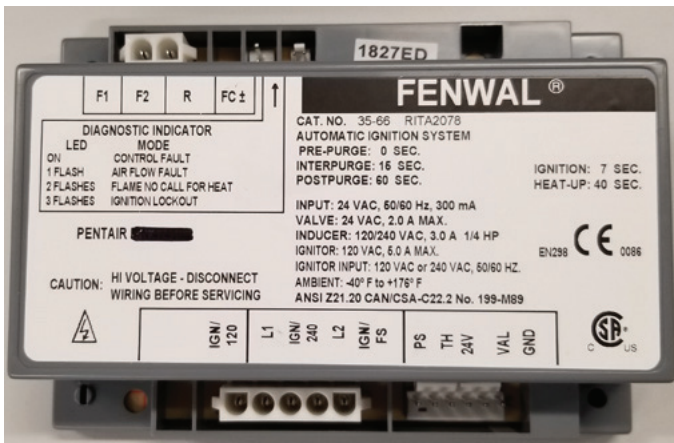

P/N 476223 Parts List

P/N	Description	Qty.
476221	ICM F/FLAME SENSE DOM	1
476206	ADAPT 6 PIN FOR DOM ICM AFTR RS485	1
476208	ADAPT F1-F2 FOR DOM ICM AFTER RS485	1
476202	ADAPT 5PIN FOR DOM ICM AFTER RS485	1
476213	LED WIRE ADAPTER	1
476249	INSTALLATION INSTRUCTIONS	1

ICM Fenwal® (USA) P/N 476221

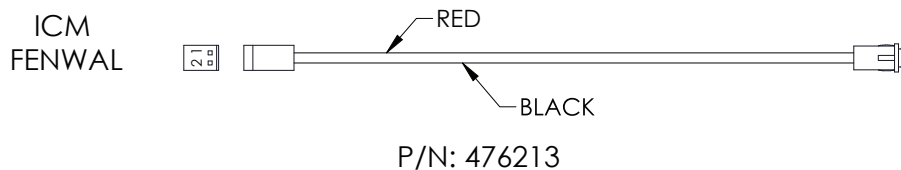
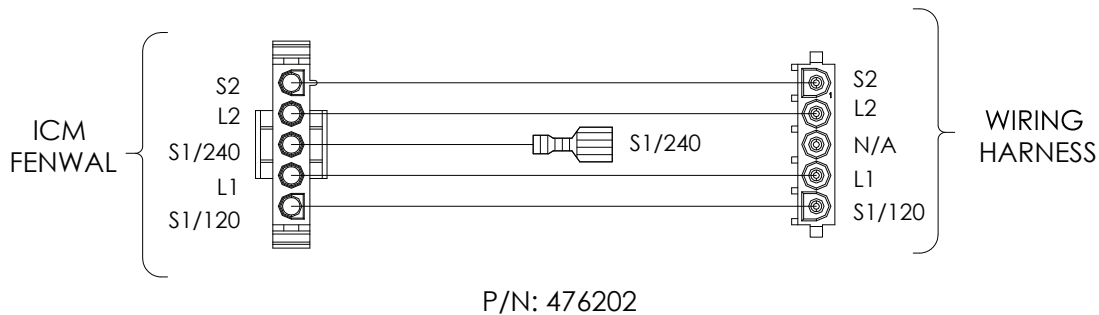
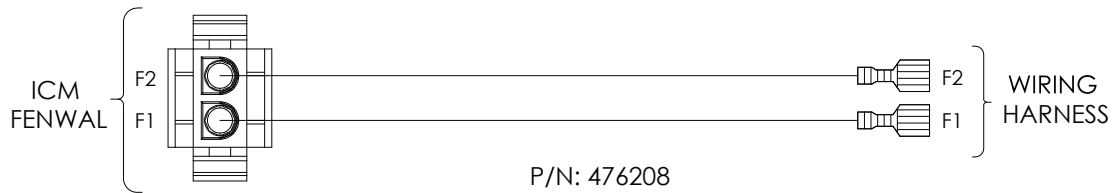
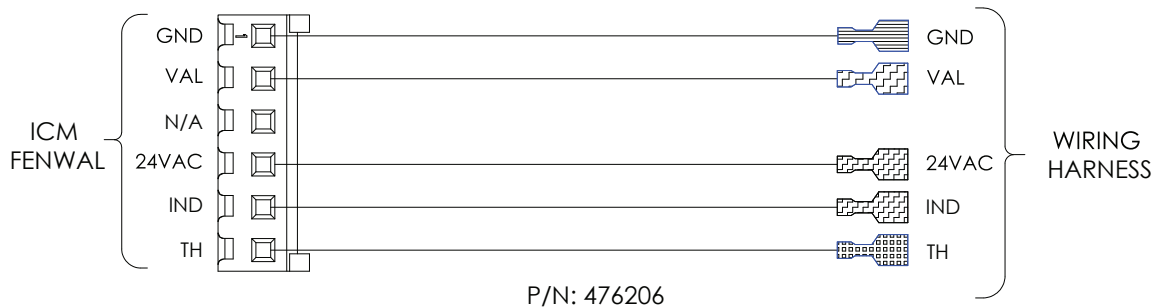

HEATER ICM REPLACEMENT INSTRUCTIONS (USA)

When installing this kit, **basic safety precautions** should always be followed. Read and follow all instructions.

Required installation tools:

- Powered socket/nut driver
- 1/4" nut driver bit
- 5/16" socket and nut driver
- 3/8" nut driver

CAUTION!: Before unplugging ICM connector plugs, be sure to match the wire label on both the existing and replacement wire harnesses.

To replace the ICM on a MasterTemp® or Max-E-Therm® Heater:

1. **MasterTemp Heater:** Remove left side panel from the heater (Fig. 1 and Fig. 2).



FIG. 1.
MasterTemp STD Heater



FIG. 2.
MasterTemp 125 Heater

2. **Max-E-Therm Heater:** Remove the four (4) bolts from the heater jackets. Remove, see Fig. 3.

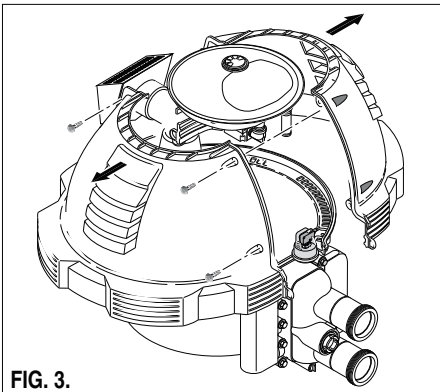

FIG. 3.
Max-E-Therm Heater

3. **LEGACY ICM (P/N 42001-0100):** Disconnect all connector plugs and wires from the legacy ICM. Remove the two (2) mounting screws from the legacy ICM. Remove the legacy ICM unit from the heater.
4. **Install the ICM (P/N 476221):** Install the ICM into the heater Junction Box compartment. Secure the unit with the two (2)

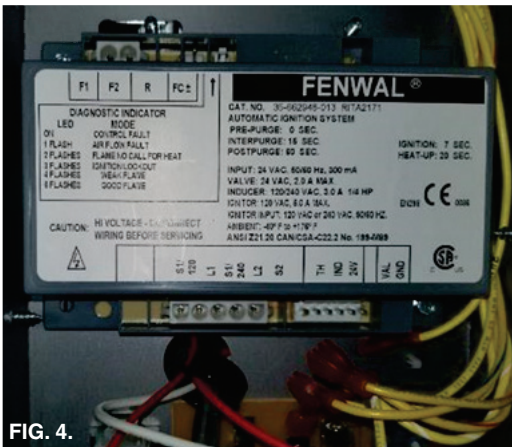

FIG. 4.

5. Connect the ICM to wire adapter (P/N 476208) for **F1 and F2** as shown in Fig. 5. One end of the adapter is a two position Molex® connector that connects to the ICM. The other end of the adapter is a 1/4" male quick connect terminal.

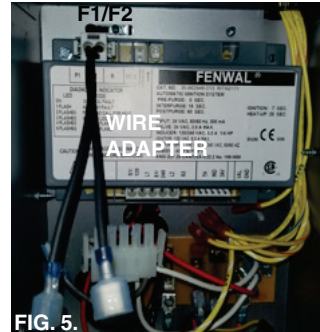

FIG. 5.

6. Connect the wire adapter (P/N 476202) with five position connector housing to the ICM (see Fig. 6). Leave the female connector header on the other end.



FIG. 6.

7. Connect the last wire adapter (P/N 476206) to the lower right side of the ICM (see Fig. 7.). **Notice that the new ICM no longer has the 24V or R connection of the ICM in the upper left side. The 24 V is now in the multi pin connector header. Additionally, one location of the multi-pin connector is not in use, which is in between 24V and VAL.**

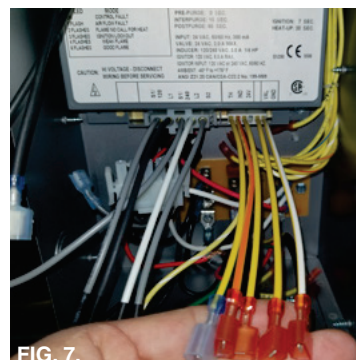

FIG. 7.

HEATER ICM REPLACEMENT INSTRUCTIONS (USA)

Now that the wire adapters are connected to the ICM. Proceed connecting each end of the wire adapters to the existing wire harness as follow:

- Connect the male terminals from F1 and F2 to the corresponding F1 and F2 cables of the wire harness as shown in Fig. 8 and Fig. 9.

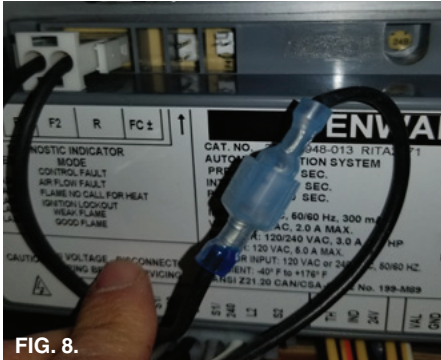

FIG. 8.

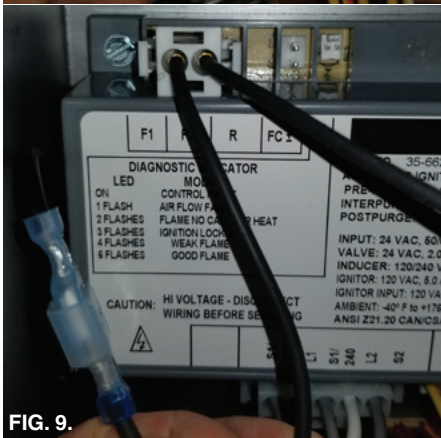

FIG. 9.

- Connect the Molex connector as shown in Fig. 10. Be sure the two end flat connections mate properly.

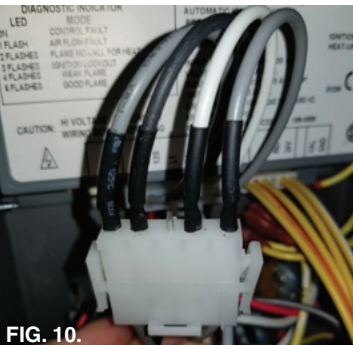

FIG. 10.

- The new ICM does not have a 240-spade terminal; this connection is now in the middle of the Molex connector. The wire adapter has a cable coming out of the Molex that needs to be connected to the 240 gray cable as shown in Fig. 11.



FIG. 11.

- Connect the yellow/white wire coming from GND in the ICM to the GND cable as shown in Fig. 12.

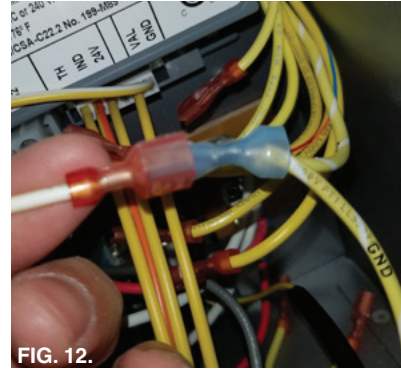

FIG. 12.

- Connect the red/yellow wire coming out of the multi-pin connector to the red/yellow wire coming from the PCBA as shown in Fig. 13.

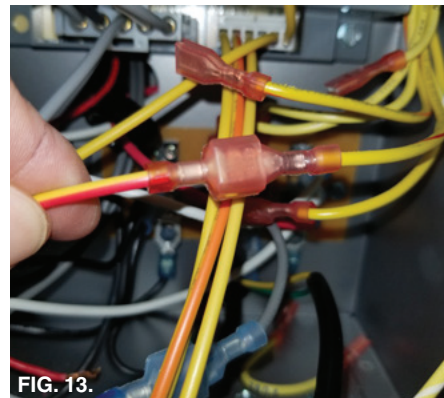

FIG. 13.

- Connect the yellow wire labeled 24V from the multi-pin connector to the yellow wire labeled 24V coming from the PCBA as shown in Fig. 14.

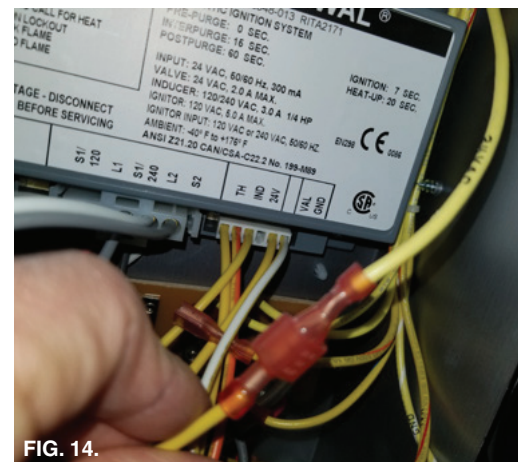
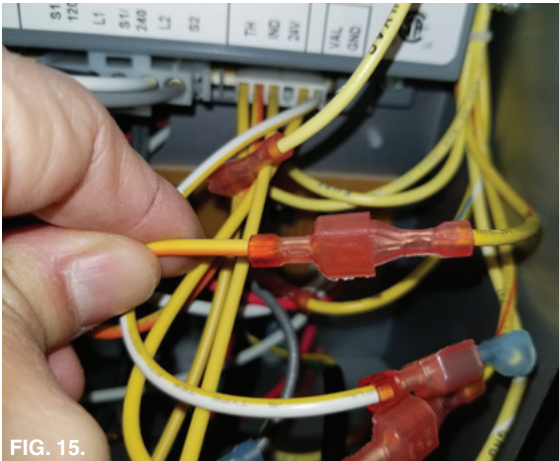

FIG. 14.

- Reassemble the heater control panel assembly. Be sure that the control panel can be adjusted without having to lean over the exhaust vent.

HEATER ICM REPLACEMENT INSTRUCTIONS (USA)

14. Connect the Orange/yellow wire labeled IND to the Orange/yellow wire labeled IND that comes from the PCBA as shown in Fig. 15.



15. Connect the Blue/Yellow wire labeled TH to the Blue/Yellow wire labeled TH that comes from the PCBA as shown in Fig. 16.

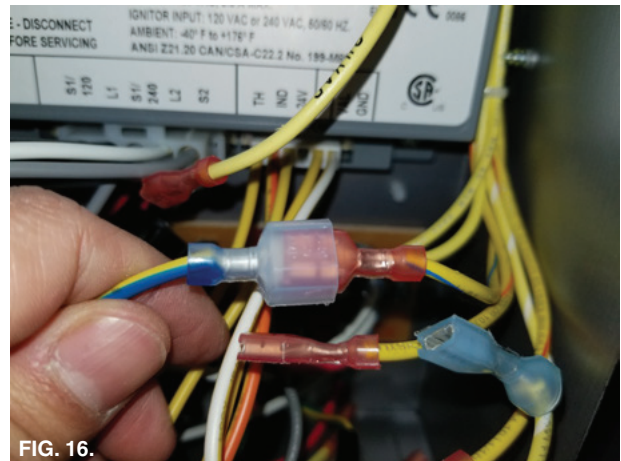

16. Connect the Red and Black cable from the PCBA to the ICM if you have the Flame sense cable. Otherwise, connect the wire adapter 476213 with Red and Black cable and LED to the ICM as shown in Fig 17.

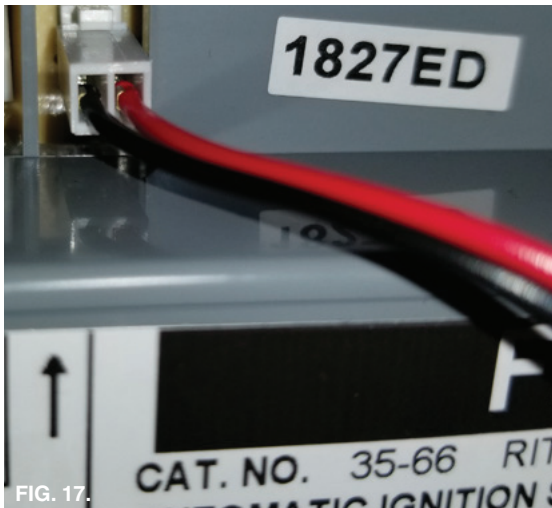

HEATER ICM REPLACEMENT INSTRUCTIONS (AUSTRALIA)

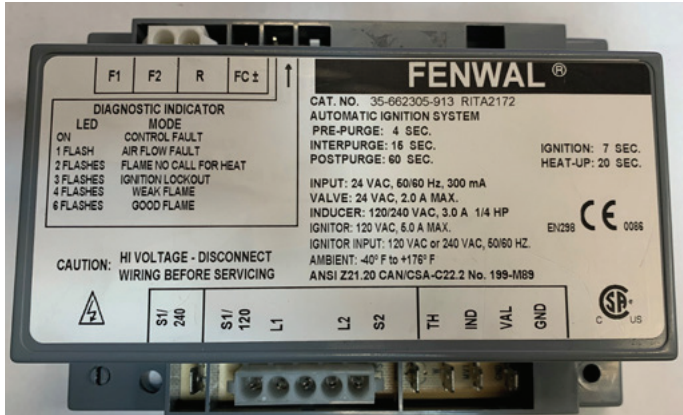

ICM Fenwal® (Australia) 2020 P/N 476222

P/N 476224 Parts List

P/N	Description	Qty.
476222	ICM W/ FLAME SENSE AUS	1
476207	ADAPT 5 PIN FOR AUS ICM AFTER RS485	1
476213	ADAPTER LED WIRE ADAPTER	1
476249	INSTALLATION INSTRUCTIONS	1

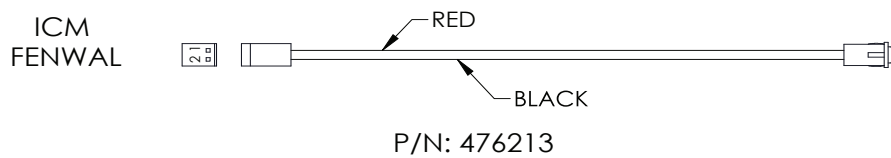
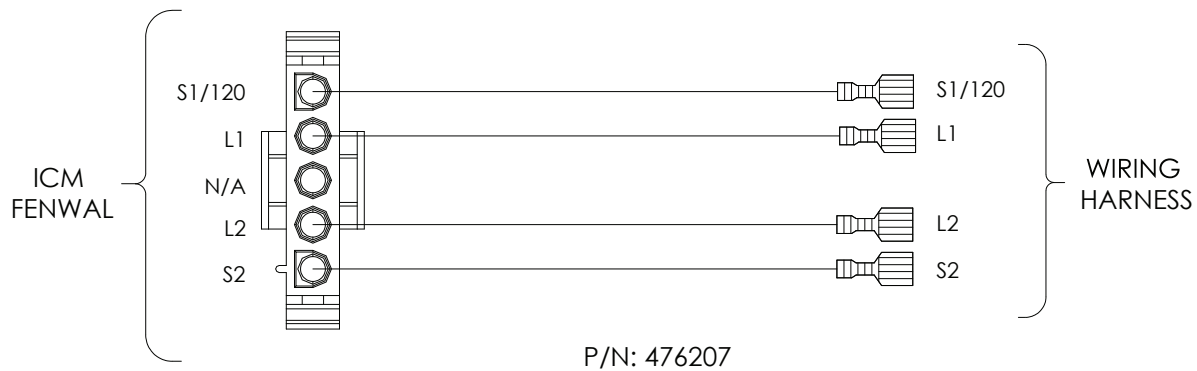

HEATER ICM REPLACEMENT INSTRUCTIONS (AUSTRALIA)

When installing this kit, **basic safety precautions** should always be followed. Read and follow all instructions.

Required installation tools:

- Powered socket/nut driver
- 1/4" nut driver bit
- 5/16" socket and nut driver
- 3/8" nut driver

CAUTION!: Before unplugging ICM connector plugs, be sure to match the wire label on both the existing and replacement wire harnesses.

To replace the ICM on a MasterTemp® or Max-E-Therm® Heater:

1. **MasterTemp Heater:** Remove left side panel from the heater (Fig. 1 and Fig. 2).



FIG. 1
MasterTemp STD Heater



FIG. 2.
MasterTemp 125 Heater

2. **Max-E-Therm Heater:** Remove the four (4) bolts from the heater jackets. Remove, see Fig. 3.

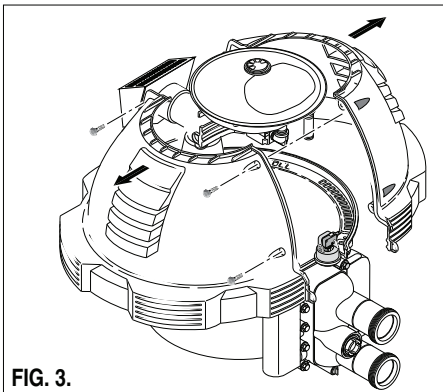

FIG. 3.
Max-E-Therm Heater

3. **LEGACY ICM (P/N 474103):** Disconnect all connector plugs and wires from the legacy ICM. Remove the two (2) mounting screws from the legacy ICM. Remove the legacy ICM unit from the heater.
4. **Install the ICM (P/N 476222):** Install the ICM into the heater

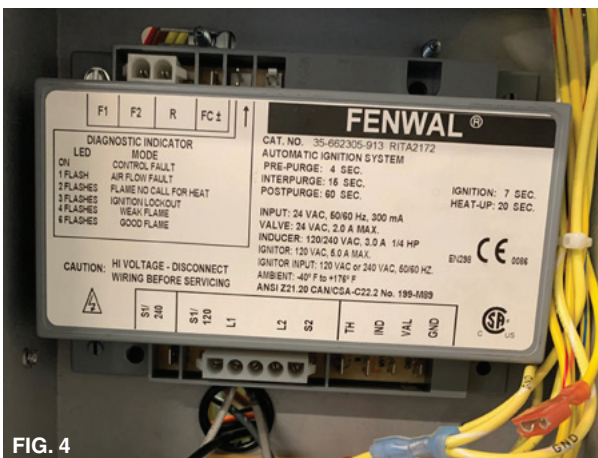

FIG. 4

5. Connect the **F1 and F2** plug as shown in Fig. 5.

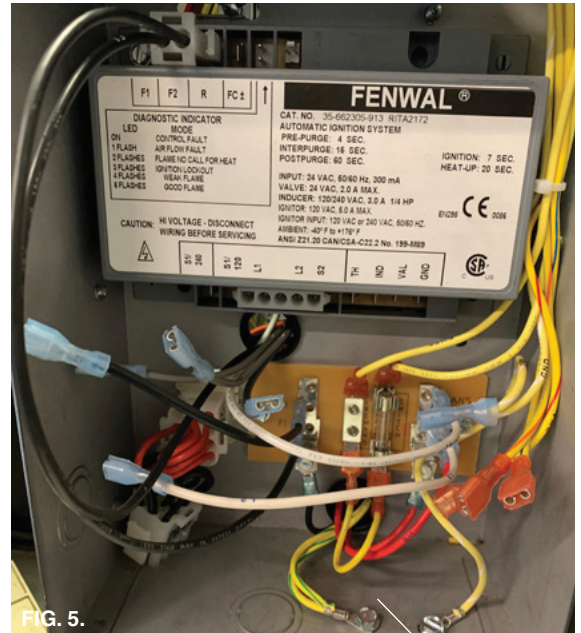

FIG. 5.

6. Connect the connector (P/N 467207) to the lower left side of the ICM (see Fig. 6).

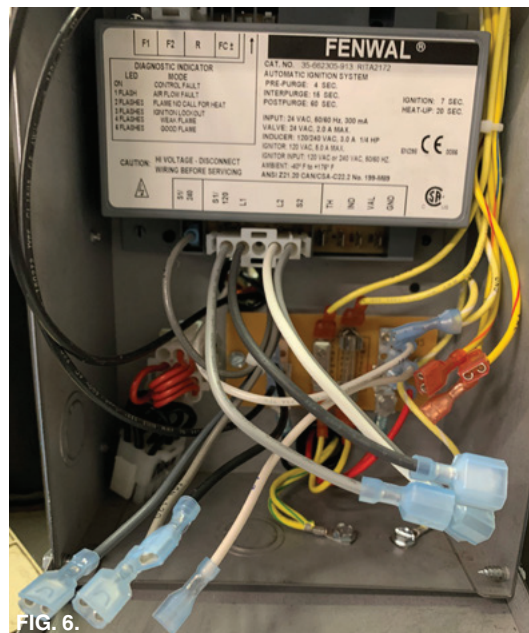

FIG. 6.

HEATER ICM REPLACEMENT INSTRUCTIONS (AUSTRALIA)

7. Connect 240VAC gray cable with ¼" female terminal to ¼" tab at the lower left side of ICM as shown in Fig. 8.

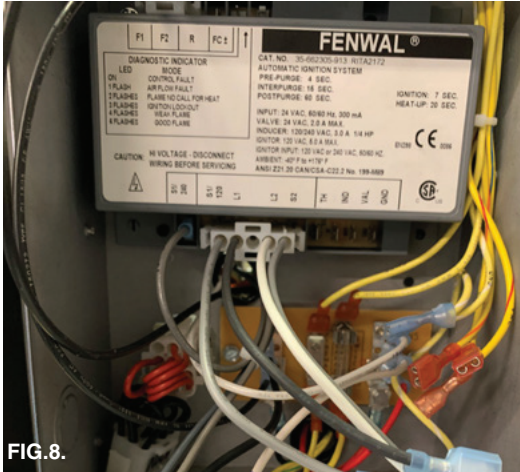

FIG. 8.

10. Connect the Red/yellow wire to VAL ¼" tab at the ICM, as shown in Fig. 11.

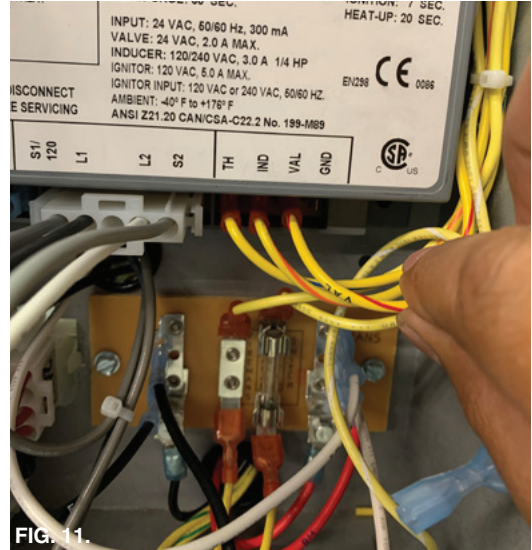

FIG. 11.

8. Connect the Blue/Yellow wire to TH ¼" tab at ICM as shown in Fig. 9.

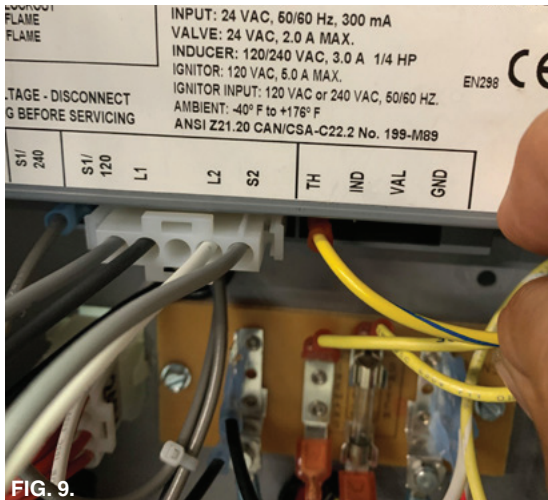

FIG. 9.

TH Connection

11. Connect the White/Yellow wire to GND ¼" tab at the ICM as shown in Fig. 12.

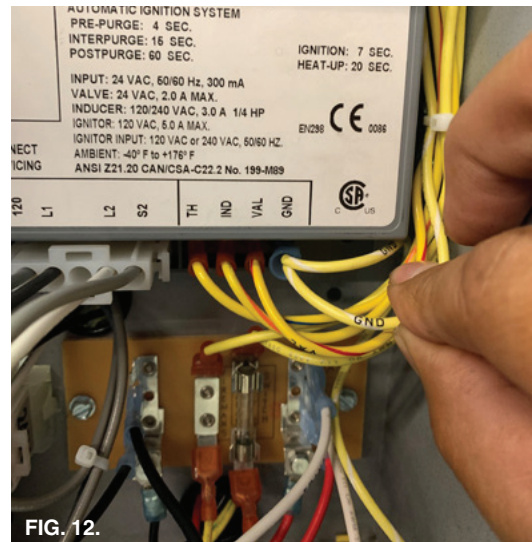

FIG. 12.

9. Connect the Orange/Yellow wire to IND ¼" tab at ICM as shown in Fig. 10.

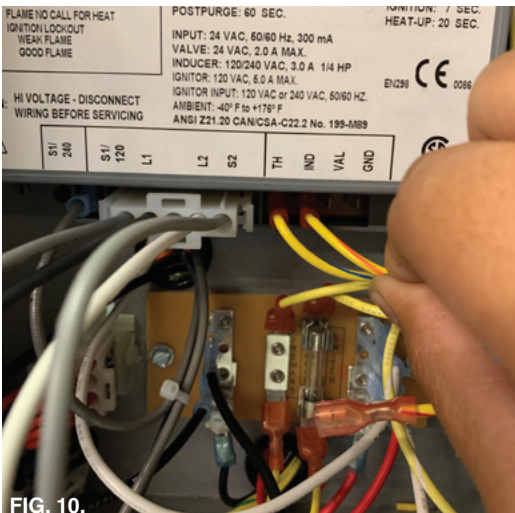

FIG. 10.

12. Connect the Red and Black cable from the PCBA to the ICM if you have the Flame sense cable. Otherwise, connect the wire adapter 476213 with Red and Black cable and LED to the ICM as shown in Fig 13.

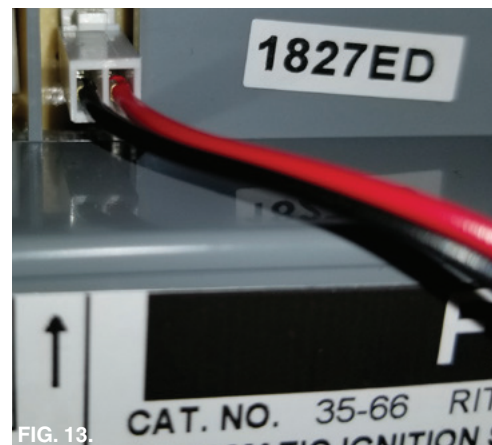

FIG. 13.

HEATER ICM REPLACEMENT INSTRUCTIONS (AUSTRALIA)

13. Connect the 24 VAC plug at the upper right side as shown in

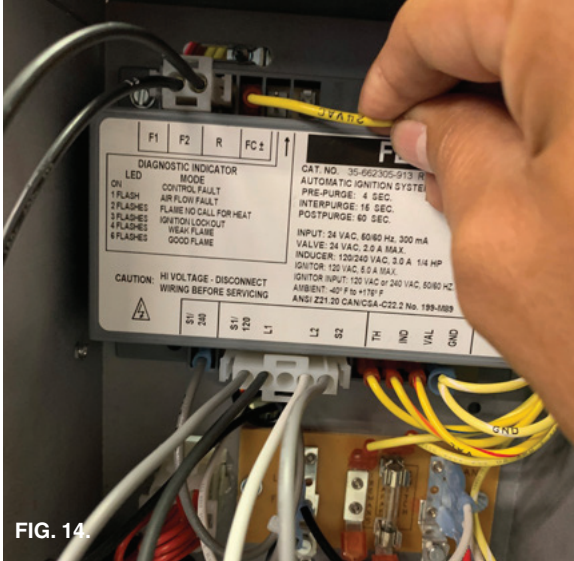

FIG. 14.

Connect 24VAC plug.

15. Reassemble the heater control panel assembly. Be sure that the control panel can be adjusted without having to lean over the exhaust vent.

14. Connect L1, L2, 120 VAC and S2 as shown in FIG. 15.

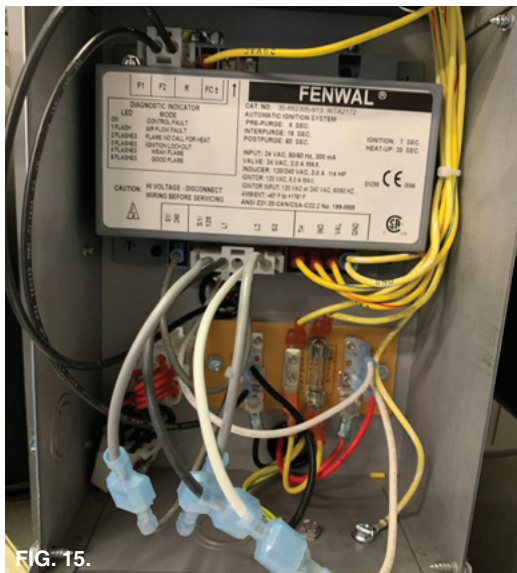

FIG. 15.

Connect L1, L2, 120 VAC and S2 as shown in Fig 15.

NOTES

NOTES



1620 HAWKINS AVE., SANFORD, NC 27330 • (919) 566-8000
10951 WEST LOS ANGELES AVE., MOORPARK, CA 93021 • (805) 553-5000

Technical Support: 800.831.7133

www.pentair.com

All indicated Pentair trademarks and logos are property of Pentair Inc. or its global affiliates in the U.S.A. and/or other countries. Third party registered and unregistered trademarks and logos are the property of their respective owners. Fenwal® is a registered trademark of Kidde-Fenwal, Inc. in the United States and/or other countries.

© 2020 Pentair. All rights reserved. This document is subject to change without notice.



P/N 476249.A 9/2020